

+GF+ SIGNET

8550-1 Flow Transmitter



3-8550.090-1



G-4/03 English



WARNING!

- Remove power to unit before wiring input and output connections.
- Follow instructions carefully to avoid personal injury.

Contents

1. Specifications
2. Installation
3. Electrical Connections
4. Menu Functions

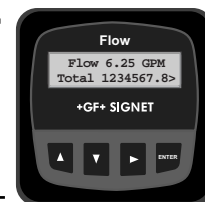

1. Specifications

Dimensions

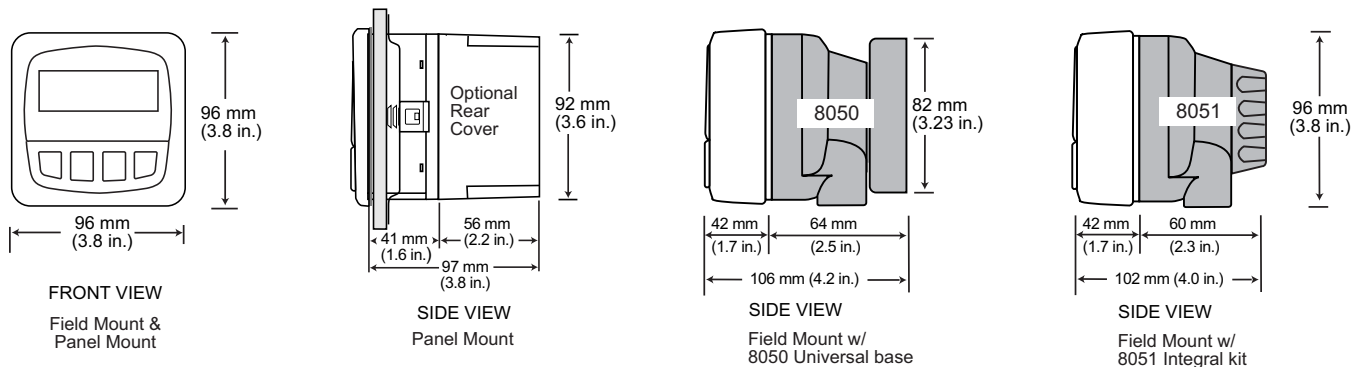

General

Compatibility: +GF+ SIGNET Flow Sensors (w/freq out)

Enclosure:

- Rating: NEMA 4X/IP65 front
- Case: PBT
- Panel case gasket: Neoprene
- Window: Polyurethane coated polycarbonate
- Keypad: Sealed 4-key silicone rubber
- Weight: Approx. 325g (12 oz.)

Display:

- Alphanumeric 2 x 16 LCD
- Update rate: 1 second
- Contrast: User selected, 5 levels
- Display accuracy: $\pm 0.5\%$ of reading @ 25°C
- Thermal sensitivity shift: $\pm 0.005\%$ of reading per °C

Electrical

- Power: 12 to 24 VDC $\pm 10\%$, regulated, 61 mA max current

Sensor Input:

- Range: 0.5 to 1500 Hz
- Sensor power: 2-wire: 1.5 mA @ 5 VDC $\pm 1\%$
3 or 4 wire: 20 mA @ 5 VDC $\pm 1\%$
- Optically isolated from current loop
- Short circuit protected

Current output:

- 4 to 20 mA, isolated, fully adjustable and reversible
- Max loop impedance: 50 Ω max. @ 12 V
325 Ω max. @ 18 V
600 Ω max. @ 24V
- Update rate: 100 ms
- Accuracy: ± 0.03 mA

Open-collector output, optically isolated:

- 50 mA max. sink, 30 VDC maximum pull-up voltage.
- Programmable for:
 - High or Low setpoint with adjustable hysteresis
 - Pulse operation (max rate: 300 pulses/min).

Environmental

- Operating temperature: -10 to 70°C (14 to 158°F)
- Storage temperature: -15 to 80°C (5 to 176°F)
- Relative humidity: 0 to 95%, non-condensing
- Maximum altitude: 2000 m (6562 ft)
- Insulation category: II
- Pollution degree: 2

Standards and Approvals

- CSA, CE, UL listed
- Immunity: EN50082-2
- Emissions: EN55011 Class B
- Manufactured under ISO 9001 and ISO 14001

2. Installation

ProcessPro transmitters are available in two styles: panel mount and field mount. The panel mount is supplied with the necessary hardware to install the transmitter. This manual includes complete panel mounting instructions.

Field mounting requires one of two separate mounting kits. The 3-8051 integral kit joins the sensor and instrument together into a single package. The 3-8050 Universal kit enables the transmitter to be installed virtually anywhere.

Detailed instructions for integral mounting or other field installation options are included with the 3-8051 Integral kit or the 3-8050 Universal kit.

2.1 Panel Installation

1. The panel mount transmitter is designed for installation using a 1/4 DIN Punch. For manual panel cutout, an adhesive template is provided as an installation guide. Recommended clearance on all sides between instruments is 1 inch.
2. Place gasket on instrument, and install in panel.
3. Slide mounting bracket over back of instrument until quick-clips snap into latches on side of instrument.
4. To remove, secure instrument temporarily with tape from front or grip from rear of instrument. DO NOT RELEASE.

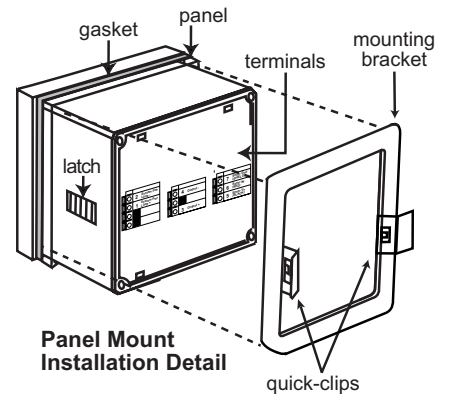

Press quick-clips outward and remove.

3. Electrical Connections



Caution: Failure to fully open terminal jaws before removing wire may permanently damage instrument.

Wiring Procedure

1. Remove 0.5 - 0.625 in. (13-16 mm) of insulation from wire end.
2. Press the orange terminal lever downward with a small screwdriver to open terminal jaws.
3. Insert exposed (non-insulated) wire end in terminal hole until it bottoms out.
4. Release orange terminal lever to secure wire in place. Gently pull on each wire to ensure a good connection.



Wiring Removal Procedure

1. Press the orange terminal lever downward with a small screwdriver to open terminal jaws.
2. When fully open, remove wire from terminal.

Terminals 3 and 4: Loop Power
 12-24 VDC $\pm 10\%$ system power
 and current loop output.
 Max. loop impedance:
 50 Ω max. @ 12 V
 325 Ω max. @ 18 V
 600 Ω max. @ 24 V

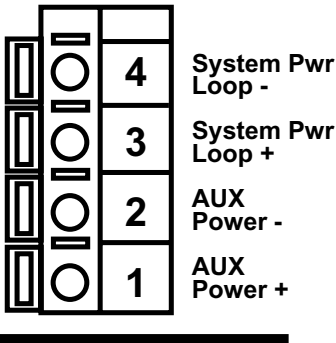

Terminals 7-9: Flow sensor input

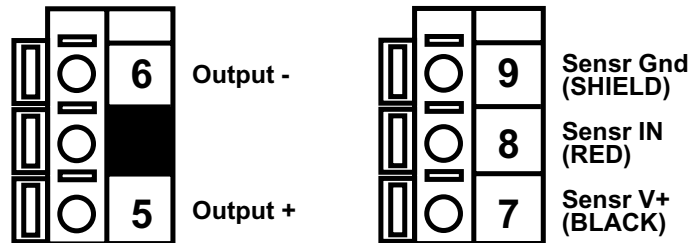

Terminals 1 and 2: AUXILIARY power
 Used only if the flow sensor requires more than 1.5 mA current. For Signet sensors this is limited to the following products:

- 2000
- 2507
- 2530
- 2535
- 2540 if mfg. prior to Jan 1999
- 7002 Vortex sensor

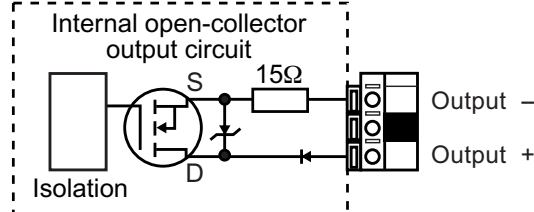

Terminals 5 and 6: Open-collector Output

A transistor output, programmable (see CALIBRATE menu) as:

- High or Low setpoint with adjustable hysteresis
- Volumetric pulse
- Frequency based on flow rate
- May be disabled (Off) if not used.

3.1 System Power/Loop Connections

Stand-alone application, no current loop used

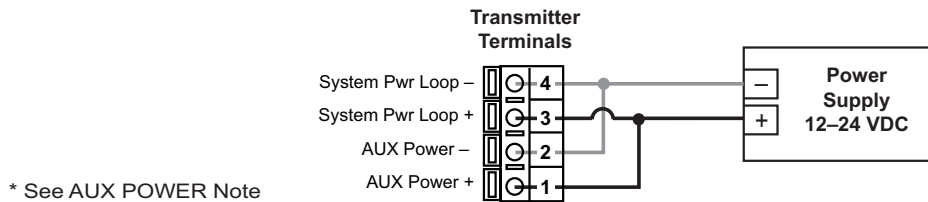

Connection to a PLC/Recorder, separate supply

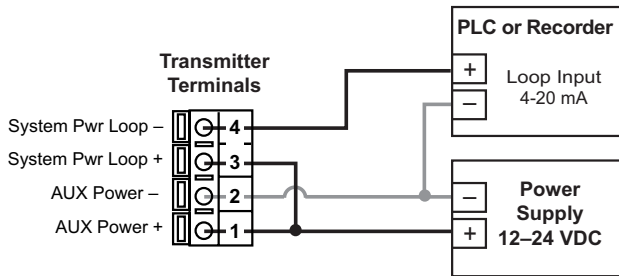

Connection to a PLC with built-in power supply

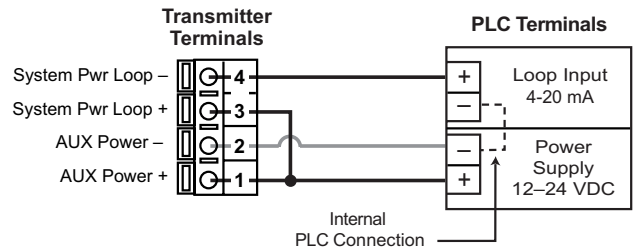

Example: Two transmitters connected to PLC/Recorder with separate power supply

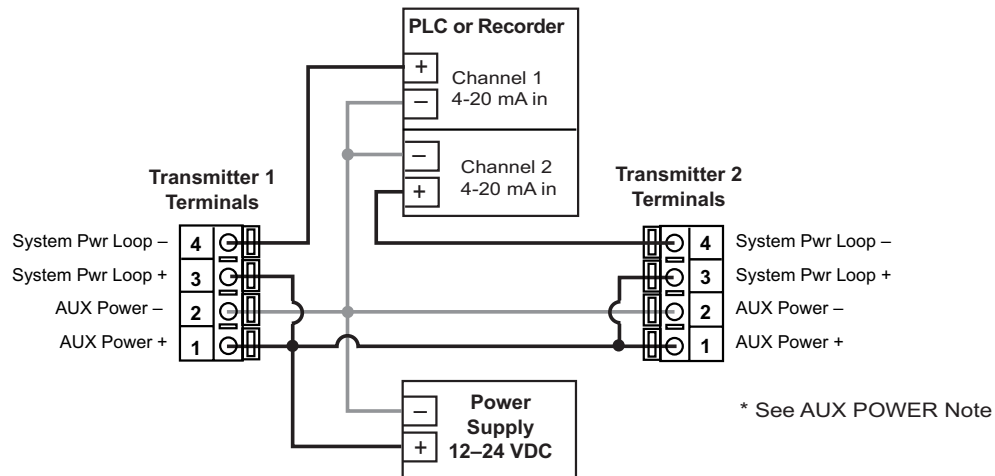

Auxiliary Power note:

AUXILIARY power is used only if the flow sensor requires more than 1.5 mA current. For Signet sensors this is limited to the following products:

- 2000, 2507, 2530, 2535, 2540 if mfg. prior to Jan 1999, 7002 Vortex sensor

3.2 Sensor Input Connections

Wiring Tips:

- Do not route sensor cable in conduit containing AC power wiring. Electrical noise may interfere with sensor signal.
- Routing sensor cable in grounded metal conduit will help prevent electrical noise and mechanical damage.
- Seal cable entry points to prevent moisture damage.
- Only one wire should be inserted into a terminal. Splice double wires outside the terminal.

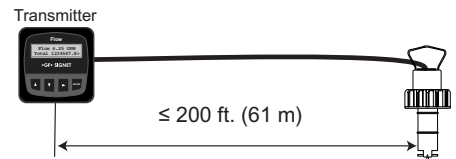

Maximum cable length is 200 ft. for 515/8510-XX, 525, 2517 and any sinusoidal flow signal.

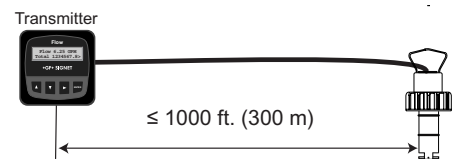

Maximum cable length is 1000 ft. for 2536/8512-XX, 2540/2541, vortex, and any open collector flow signal.

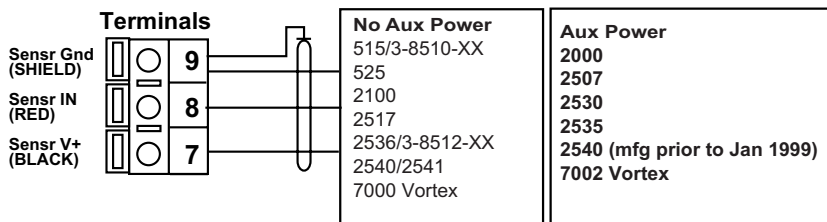



3.3 Open Collector Output

The Open collector output can be used as a switch that responds when the flow rate moves above or below a setpoint, or it can be used to generate a pulse that is relative to the flow volume or to the flow rate.

- Low**
 Output triggers when the flow rate is less than the setpoint. The output will relax when the flow rate moves above the setpoint plus the hysteresis value.
- High**
 Output triggers when the flow rate is greater than the setpoint. The output will relax when the flow rate drops below the setpoint plus the hysteresis value.
- Frequency**
 Output is a pulse stream that is based on the input flow sensor signal. Set for 1 (input frequency = output frequency). Set for even numbers (2, 4, 6, 8 254 maximum) to scale output frequency.
- Pulse**
 Output is a pulse based on the volume of fluid that passes the sensor. Set any value from 0.0001 to 99999.

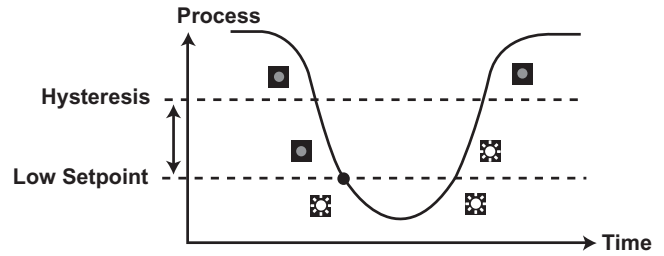
The output may be disabled (Off) if not used.



Relay energized 
 Relay relaxed 

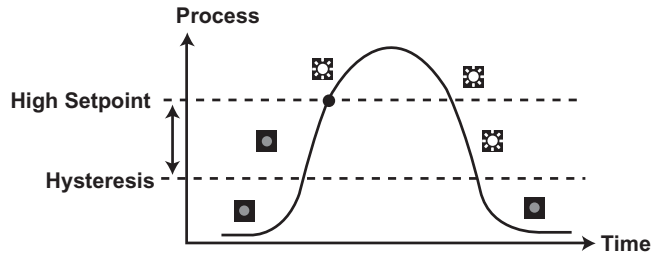

VIEW menu

- During normal operation, the ProcessPro displays the VIEW menu.
- When using the CALIBRATE or OPTIONS menus, the ProcessPro will return to the VIEW menu if no activity occurs for 10 minutes.
- To select the item you want displayed, press the UP or DOWN arrow keys. The items will scroll in a continuous loop. Changing the display selection does not interrupt system operations.
- No key code is necessary to change display selection.
- Output settings cannot be edited from the VIEW menu.

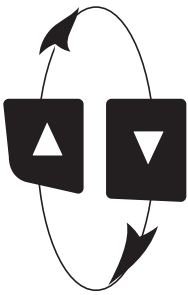

View Menu

Display	Description
0.0 GPM Total: 12345678 >	Monitor the flow rate and the resettable totalizer. Press the RIGHT ARROW key to reset the totalizer. If the Reset is locked, you will need to enter the Key Code first. Lock or Unlock the totalizer in the OPTIONS menu. This is the permanent View display.
Perm: 12345678 Gallons	Monitor the Permanent Totalizer value.
Loop Output: 12.00 mA	Monitor the 4-20 mA Loop output.
Last CAL: 06-30-01	Monitor date for scheduled maintenance or date of last calibration. (See description in Calibrate Menu.)

All of the displays below are temporary. After ten minutes the display will return to the permanent display.

ProcessPro Editing Procedure:

Step 1. Press and hold ENTER key:

- 2 seconds to select the CALIBRATE menu
- 5 seconds to select the OPTIONS menu.

Step 2. The Key Code is UP-UP-UP-DOWN keys in sequence.

- After entering the Key Code, the display will show the first item in the selected menu.

Step 3. Scroll menu with UP or DOWN arrow keys.

Step 4. Press RIGHT ARROW key to select menu item to be edited.

- The first display element will begin flashing.

Step 5. Press UP or DOWN keys to edit the flashing element.

- RIGHT ARROW key advances the flashing element.

Step 6. Press ENTER key to save the new setting and return to Step 3.

Notes on Step 1:

- The View Menu is normally displayed.
- The CALIBRATE and OPTIONS menus require a KEY CODE.

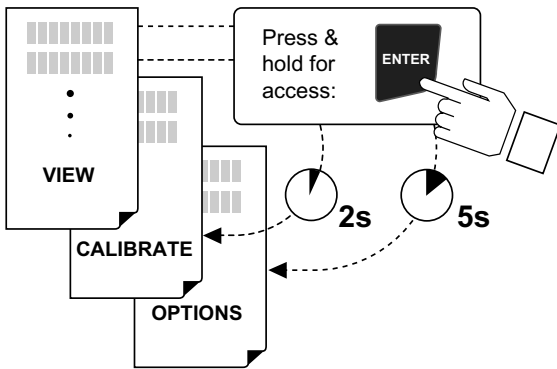

Notes on Step 2:

If no key is pressed for 5 minutes while display is showing "Enter Key Code", the display will return to the VIEW menu.

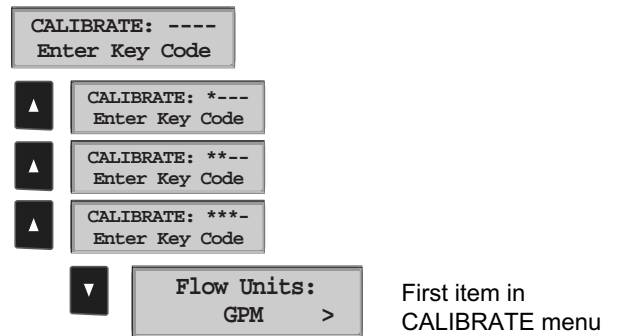

Notes on Steps 3 and 4:

- Refer to pages 6 and 7 for complete listing of menu items and their use.
- From the Step 3 display, pressing the UP and DOWN keys simultaneously will return the display to the VIEW menu.
- If no key is pressed for 10 minutes, display will also return to the VIEW menu.



Step 3: Finished Editing?
Press the UP and DOWN keys simultaneously after saving the last setting to return to normal operation.

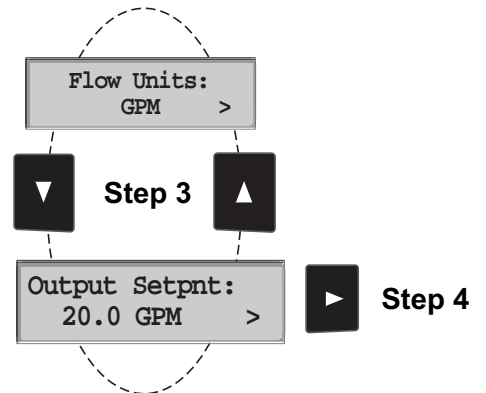

Notes on Steps 5 and 6:

- All output functions remain active during editing.
- Only the flashing element can be edited.
- RIGHT ARROW key advances the flashing element in a continuous loop.
- Edited value is effective immediately after pressing ENTER key.
- If no key is pressed for 10 minutes unit will restore the last saved value and return to step 3.
- Step 6 (pressing ENTER key) always returns you to Step 3.
- Repeat steps 3-6 until all editing is completed.

Step 5: Made an Error?

Press the UP and DOWN keys simultaneously while any element is flashing. This will recall the last saved value of the item being edited and return you to Step 3.



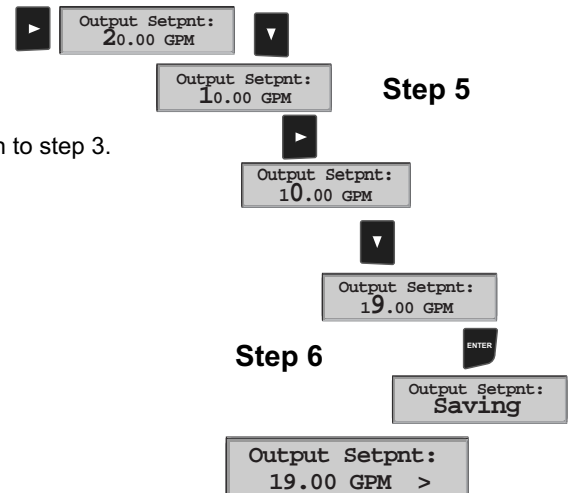

Calibrate Menu

Display (Factory settings shown)	Description
Flow Units: GPM >	The first three characters set the Flow Rate units of measure. They have no effect on calculations. They may be any alpha or numeric character, upper or lower case. The last character sets the Flow rate Timebase. Select S (seconds), M (minutes), H (hours) or D (days).
Flow K-Factor: 60 >	This setting tells the transmitter how to convert the input frequency from the flow sensor into a flow rate. The K-factor is unique to the sensor model and to the pipe size and schedule. Refer to data in the sensor manual for the correct value. Limits: 0.0001 to 99999. (The K-factor cannot be set to 0)
Total Units: Gallons >	This setting identifies the Totalizer units. It has no effect on any calculation. It serves as a label only. Each character can be any alpha or numeric selection, upper or lower case.
Total K-Factor 60 >	This setting tells the transmitter how to convert the input frequency from the flow sensor into a volumetric total. It also is used as the basis for the Open Collector pulse mode. The setting is usually the same as the Flow K-factor, or different by x10 or x100. Limits: 0.0001 to 99999. (The K-factor cannot be set to 0)
Loop Range: GPM 000.00 → 100.00 >	Select the minimum and maximum values for the 4-20 mA Current loop output. The 8550 will allow any values from 0.0000 to 99999.
Output Mode: Low >	Select the desired mode of operation for the Open Collector output. Options available are High, Low, volumetric Pulse, or Frequency. The signal may be disabled (Off) if not used.
Output Setpnt: 10.0 GPM >	In Low or High Mode, the Open Collector output will be activated when the Flow rate reaches this value. Be sure to modify this setting if you change the Flow Units.
Output Hys: 5.0 GPM >	The Open Collector output will be deactivated at Setpoint ± Hysteresis, depending on High or Low Setpoint selection. (See details on page 4.)
Output Volume: 100.00 Gallons >	In Pulse mode, the Open collector output will generate one pulse when this volume of flow passes the sensor. The measurement is based on the Total K-factor. The 8550 will allow any value from 0.0001 to 99999.
Output PlsWdth: 0.1 Seconds >	In Pulse mode, this setting defines the duration of the Open Collector output pulse. The 8550 allows any value from 0.1 seconds to 999.9 seconds.
Output Freq.: Divide by 1 >	In Frequency mode, the Open Collector output will simulate the sensor frequency, divided by this setting. Set for 1 (input frequency = output frequency). Set for even numbers (2, 4, 6, 8 . . . 254 maximum) to scale output frequency.
Last CAL: 6-30-01	Use this "note pad" to record important dates, such as annual recertification or scheduled maintenance.

Options Menu

Display (Factory settings shown)	Description
Contrast: 3 >	Adjust the LCD contrast for best viewing. A setting of 1 is lower contrast, 5 is higher. Select lower contrast if the display is in warmer ambient surroundings.
Flow Decimal ***** >	Set the decimal to the best resolution for your application. The display will automatically scale up to this restriction. Select *****. , *****. , ***. , **.* or *.***
Total Decimal *****.* >	Set the totalizer decimal to the best resolution for your application. Select *****. , *****.* , or *****.**
Averaging: Off >	OFF provides the quickest output response to changes in flow. LOW averaging = 4 seconds, HIGH averaging = 8 seconds of input signal. Longer averaging produces more stable display and output response.
Total Reset: Lock Off >	Lock Off : No key code required to reset the resettable totalizer. Lock On : The Key Code must be entered to reset the resettable totalizer.
Loop Adjust: 4.00 mA >	Adjust the minimum and maximum current output. The display value represents the precise current output. Adjustment limits: • 3.80 mA < 4.00 mA > 5.00 mA • 19.00 mA < 20.00 mA > 21.00 mA Use this setting to match the system output to any external device.
Loop Adjust: 20.00 mA >	
Output Active: Low >	Active HIGH: This setting is used to turn a device (pump, valve) ON at the setpoint. Active LOW: This setting is used to turn a device OFF at the setpoint.
Test Loop: >	Press UP or DOWN keys to manually order any output current value from 3.6 mA to 21.00 mA to test current loop output.
Test Output: >	Press UP or DOWN keys to manually toggle the state of open collector output.

Troubleshooting

Display Condition	Possible Causes	Suggested Solutions
"_ . . . _"	Flow rate exceeds display capability	<ul style="list-style-type: none"> • Increase Flow units time base • Move flow decimal one place to the right
"Pulse Overrun"	<ul style="list-style-type: none"> • Open Collector pulse rate exceeds maximum of 300 pulses per minute. • Pulse width set too wide. 	<ul style="list-style-type: none"> • Increase Pulse volume setting • Decrease pulse width setting. • Reduce system flow rate
"Value must be more than 0"	K-factors cannot be set to 0.	Enter K-factor from 0.0001 to 99999
Open Collector is always activated	<ul style="list-style-type: none"> • Hysteresis value too large • Defective transmitter 	<ul style="list-style-type: none"> • Change the hysteresis value • Replace transmitter

Ordering Information

Mfr. Part No.	Code	Description
3-8550-1	159 000 047	Flow transmitter, Field mount
3-8550-1P	159 000 048	Flow transmitter, Panel mount
3-8550-2	159 000 049	Flow transmitter, Field mount with relays
3-8550-2P	159 000 050	Flow transmitter, Panel mount with relays
3-8550-3	159 000 051	Flow transmitter, Field mount with dual input/output
3-8550-3P	159 000 052	Flow transmitter, Panel mount with dual input/output

Accessories

Mfr. Part No.	Code	Description
3-8050	159 000 184	Universal mounting kit
3-8051	159 000 187	Flow Integral Mnt NPT
3-8050.395	159 000 186	Splashproof rear cover
3-8050.396	159 000 617	RC Filter kit (for relay use)
3-0000.596	159 000 641	Heavy duty wall mount bracket
3-5000.598	198 840 225	Surface Mount Bracket
3-5000.399	198 840 224	5 x 5 inch adapter plate for +GF+ SIGNET retrofit
3-9000.392	159 000 368	Liquid tight connector kit for rear cover (includes 3 connectors)
3-9000.392-1	159 000 839	Liquid tight connector kit, NPT (1 piece)
3-9000.392-2	159 000 841	Liquid tight connector kit, PG13.5 (1 piece)
7300-7524	159 000 687	24 VDC Power Supply 7.5 W, 300mA
7300-1524	159 000 688	24 VDC Power Supply 15 W, 600mA
7300-3024	159 000 689	24 VDC Power Supply 30 W, 1.3 A
7300-5024	159 000 690	24 VDC Power Supply 50 W, 2.1 A
7300-1024	159 000 691	24 VDC Power Supply 100 W, 4.2 A

+GF+ SIGNET

Signet Scientific Company, 3401 Aerojet Avenue, El Monte, CA 91731-2882 U.S.A. • Tel. (626) 571-2770 • Fax (626) 573-2057
 For Worldwide Sales and Service, visit our website: www.gfsignet.com • Or call (in the U.S.): (800) 854-4090

